



Flexbrick®  
dressing architecture

Casos de éxito con tejidos cerámicos – Vicente Sarrablo

PIEZA  
CERÁMICA :

- ADOQUÍN
- LADRILLO
- PLAQUETA

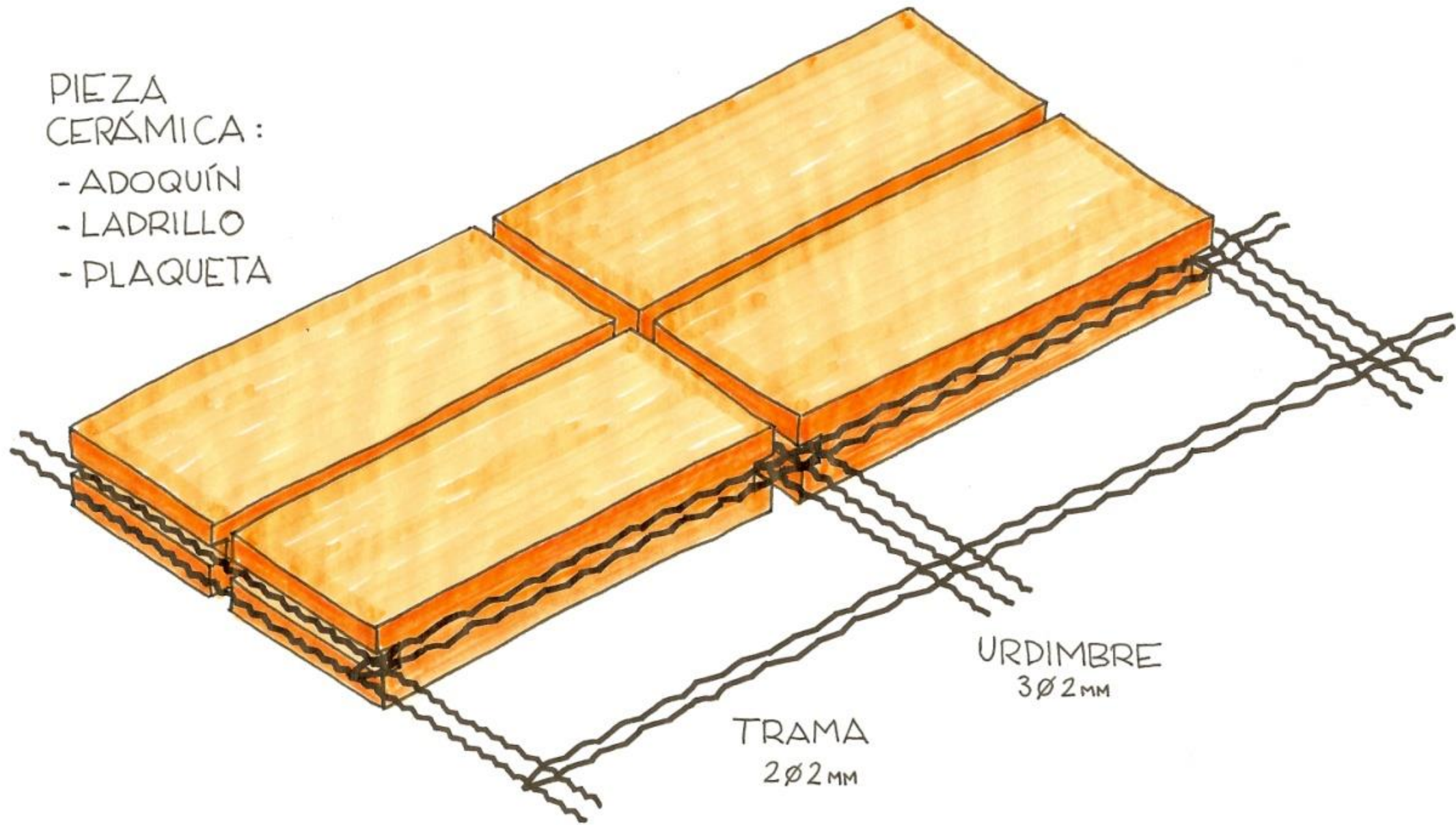

URDIMBRE  
3Ø2MM

TRAMA  
2Ø2MM





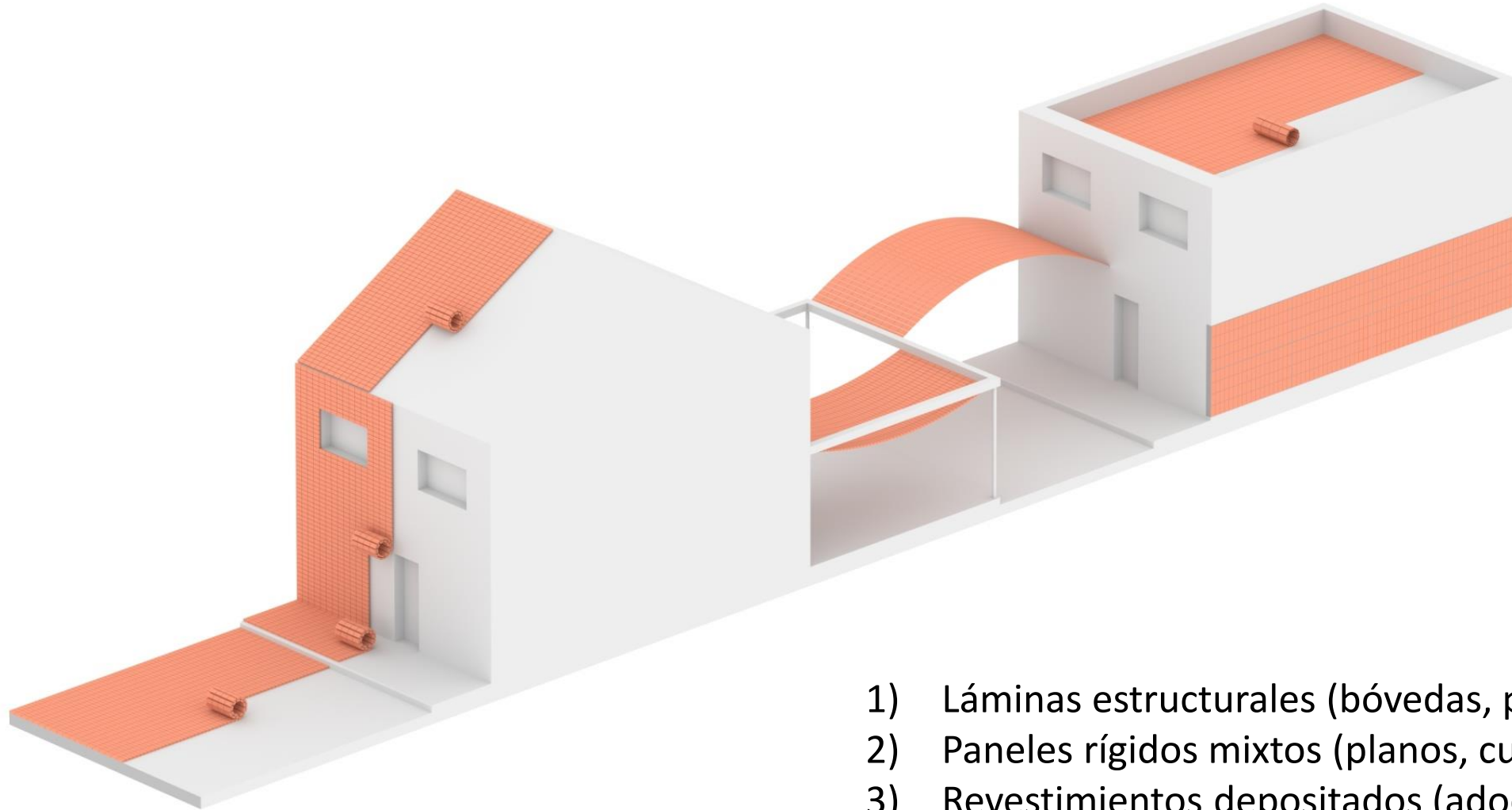

## APLICACIONES

- 1) Láminas estructurales (bóvedas, pérgolas catenarias)
- 2) Paneles rígidos mixtos (planos, curvos)
- 3) Revestimientos depositados (adoquinados drenantes y cubiertas planas, inclinadas, curvas y ajardinadas)
- 4) Revestimientos colgantes (muros cortina, celosías)
- 5) Revestimientos adheridos

Jardin Niel en Toulouse (Michele & Miquel, 2016)



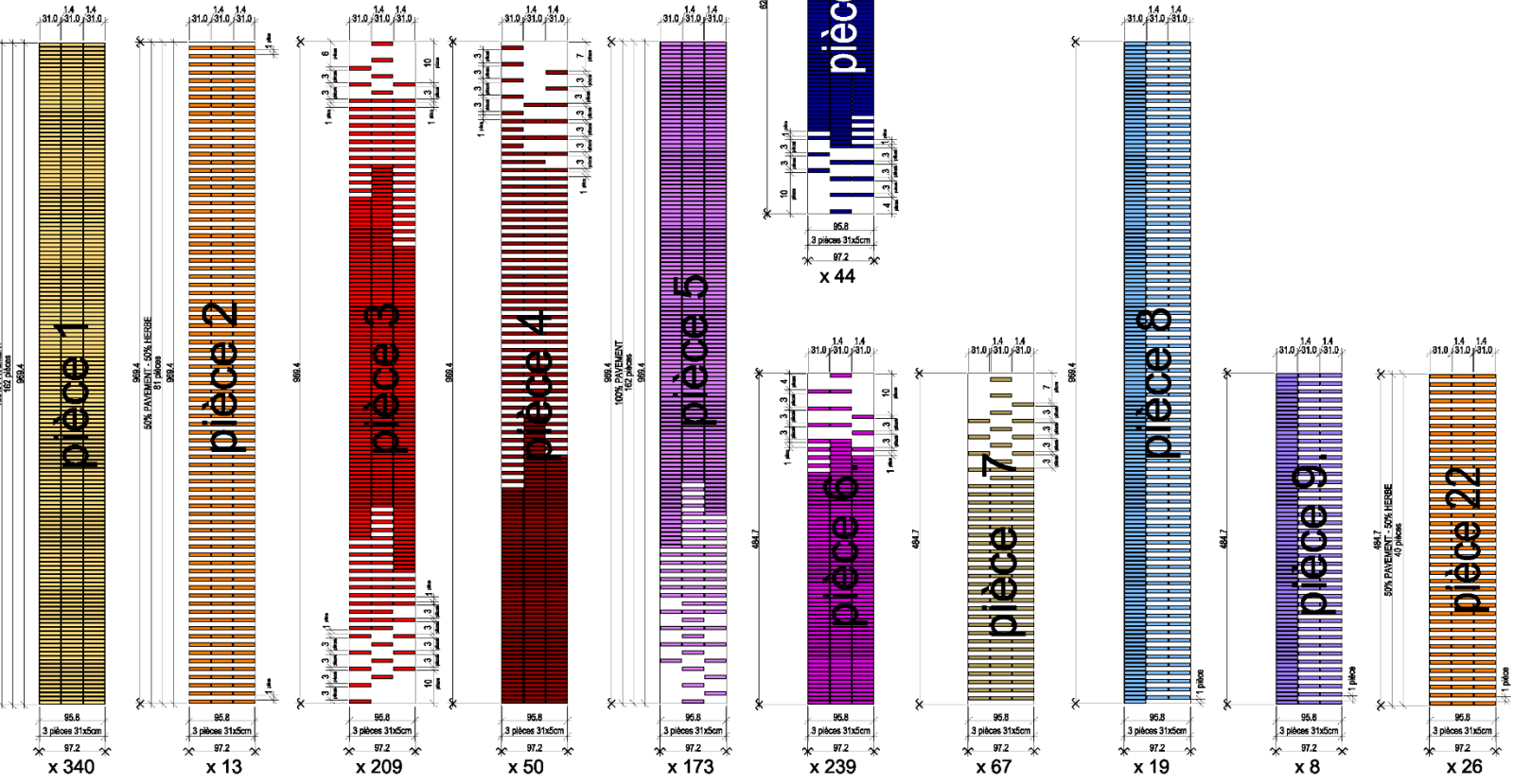

PIECE TYPE 66  
 LOCALISATION :  
 CHEMIN. DIAGONAUX

80% PAVEMENT  
 20% HERBE

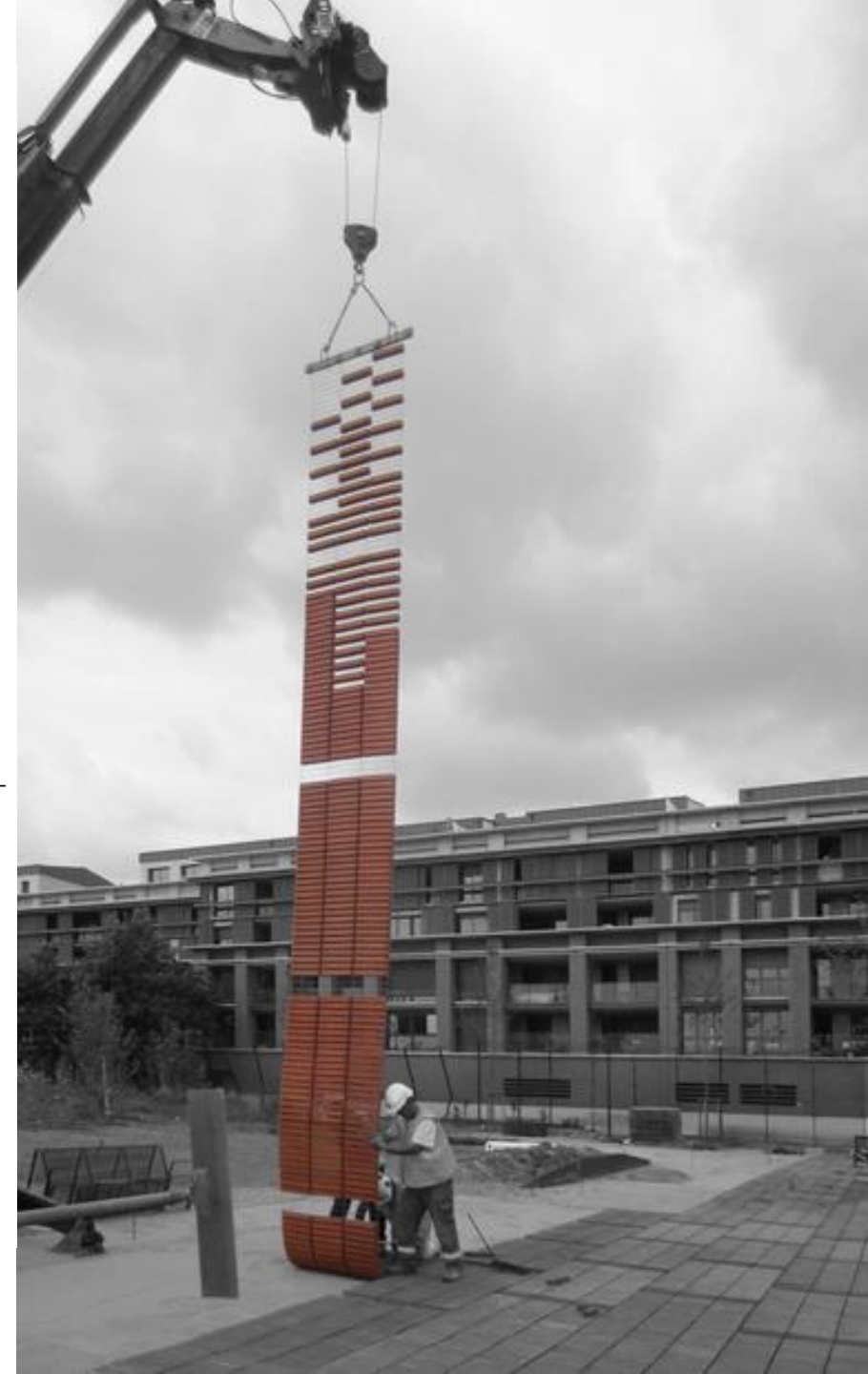





Jardin Niel en Toulouse (Michele & Miquel, 2016)

Premio FAD Internacional 2017





Palacio de Deportes para los Juegos del Mediterráneo en Tarragona  
(Barceló & Balanzó, 2018)

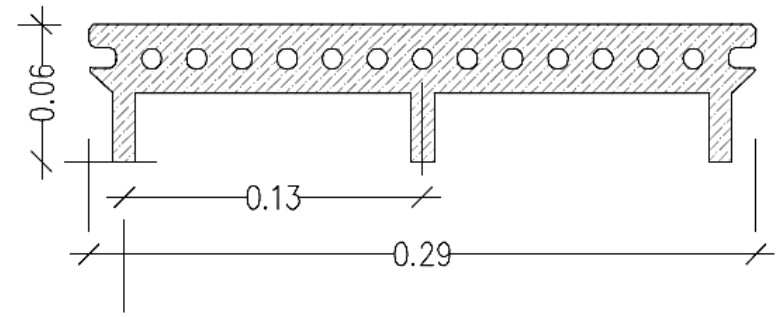
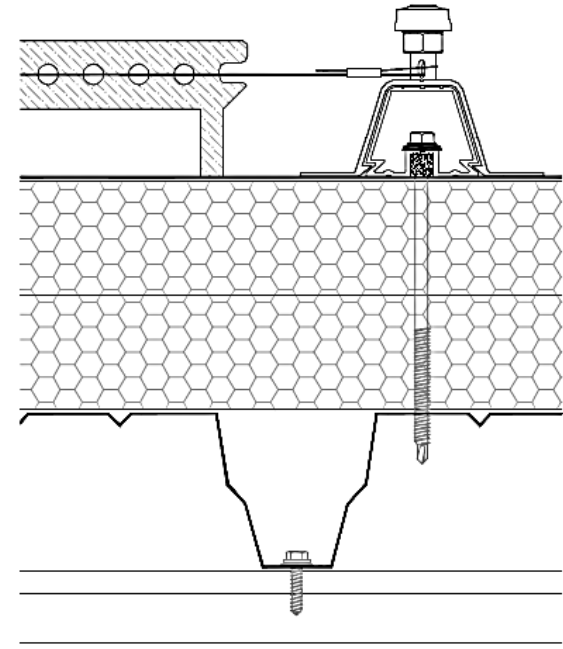
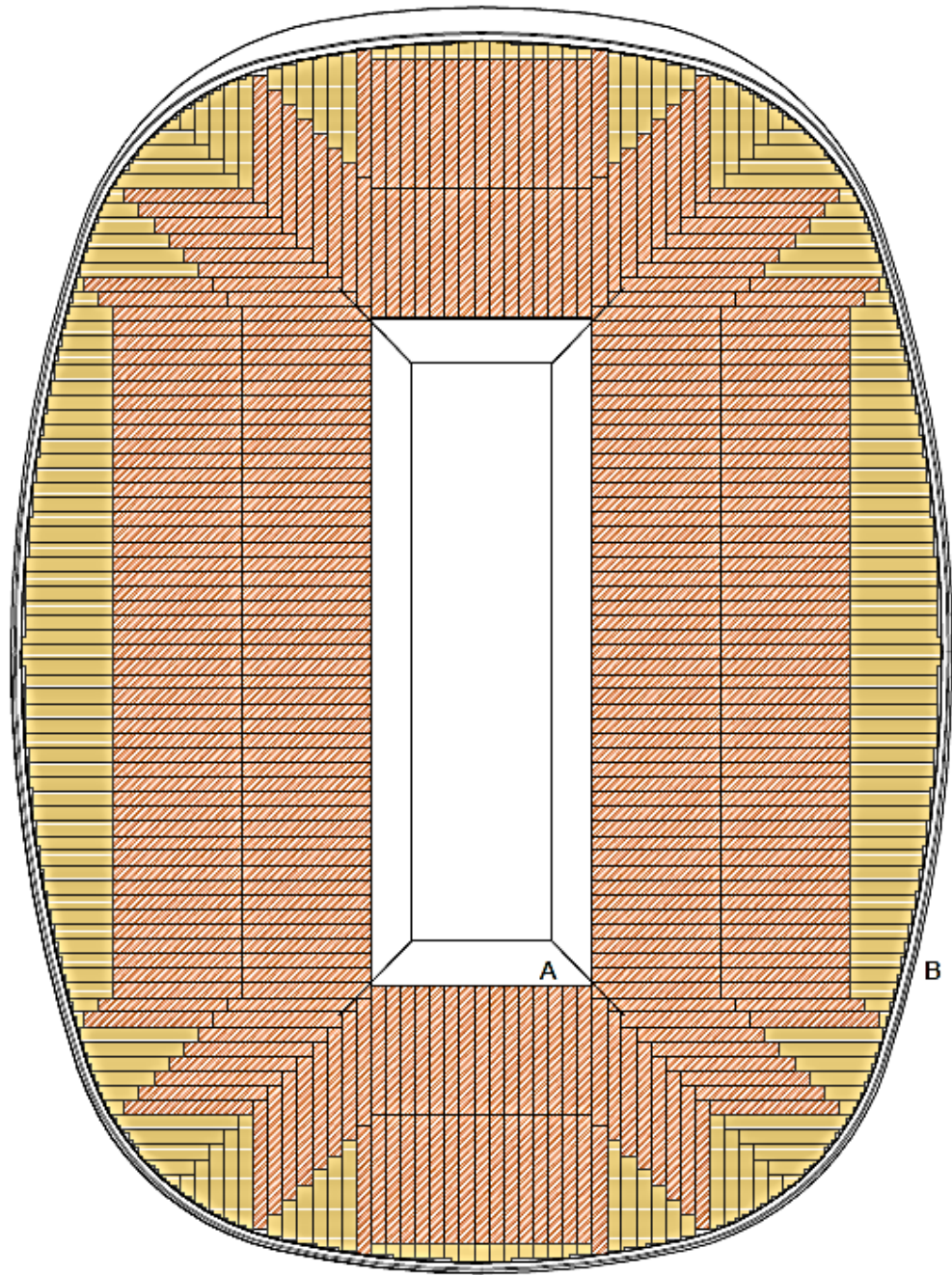





Palacio de Deportes para los Juegos del Mediterráneo en Tarragona  
(Barceló & Balanzó, 2018)

Instituto de investigación del Hospital de Sant Pau  
(Pich Architects, 2019)



PEÇA 3 (REVERS ESMALTAT)

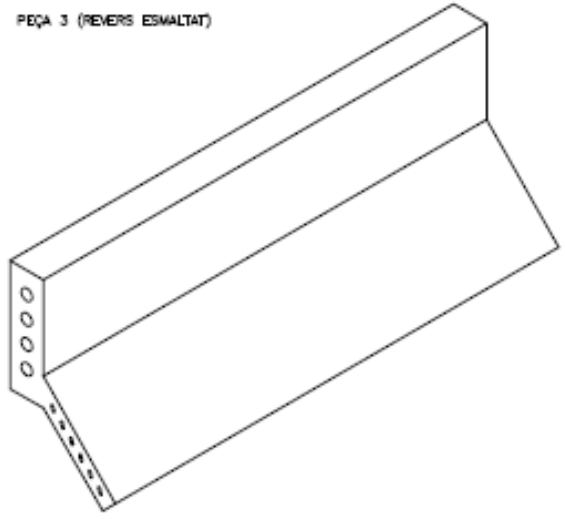

PEÇA 2 (REVERS ESMALTAT)

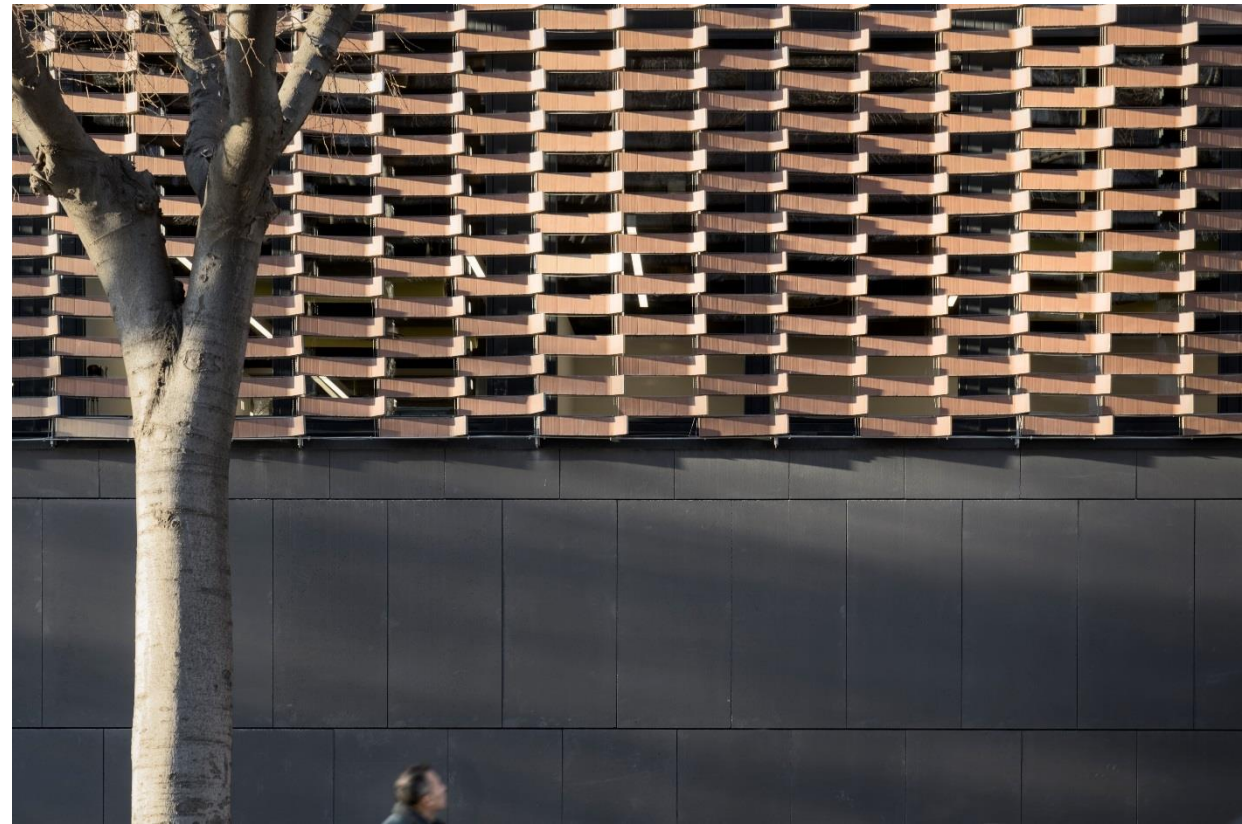
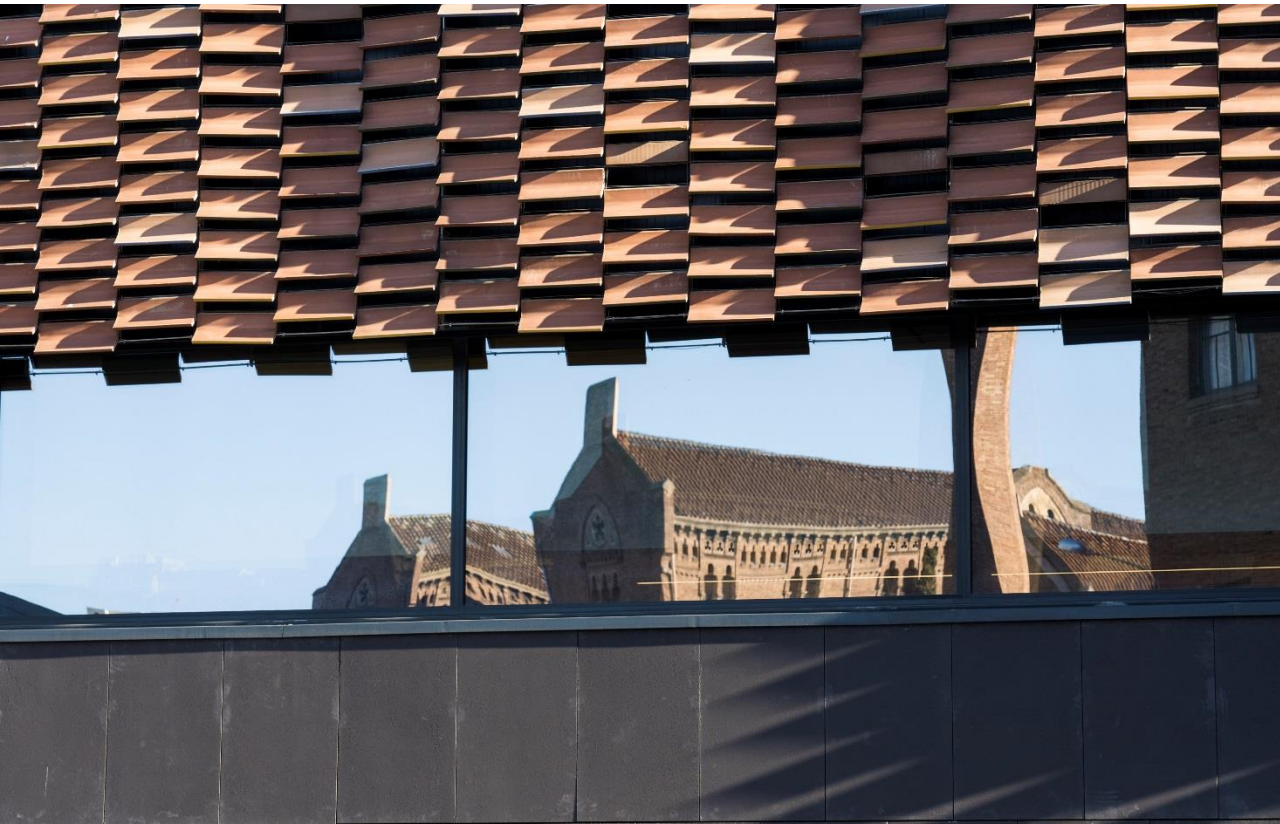
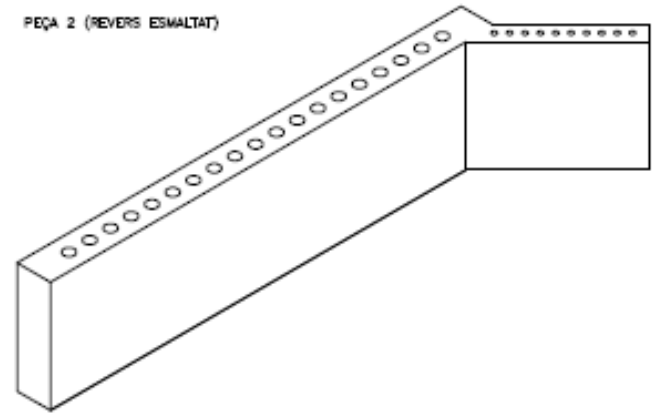







Instituto de investigación del Hospital de Sant Pau  
(Pich Architects, 2019)  
1er Premio en los XVIII Premios CERÁMICA de  
Arquitectura e Interiorismo





Rehabilitación del edificio  
Girasol de Coderch en Madrid  
(Atelier Galante, 2019)

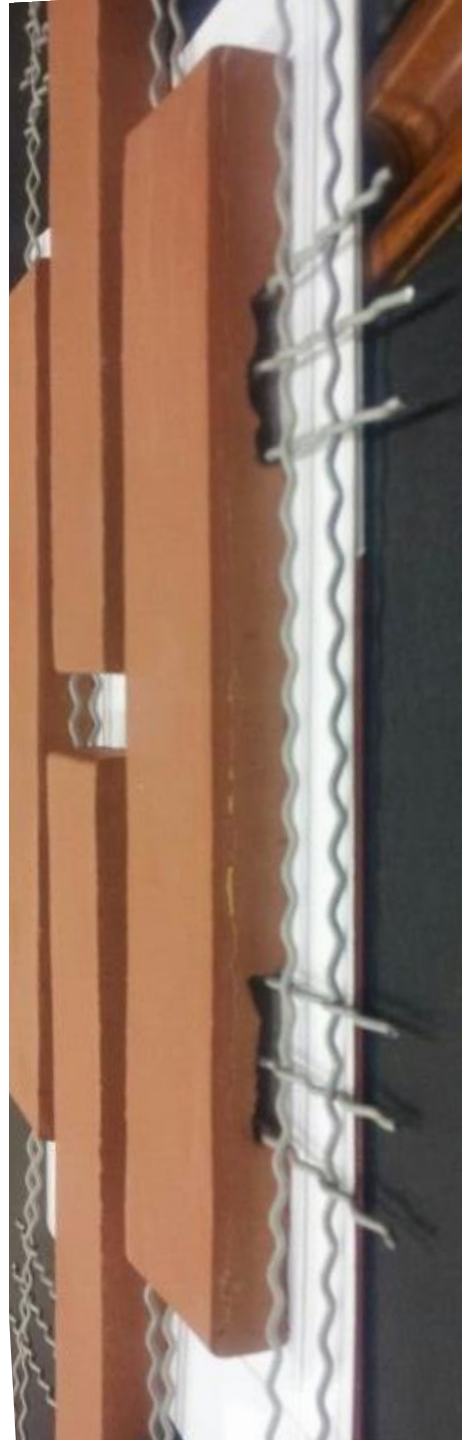
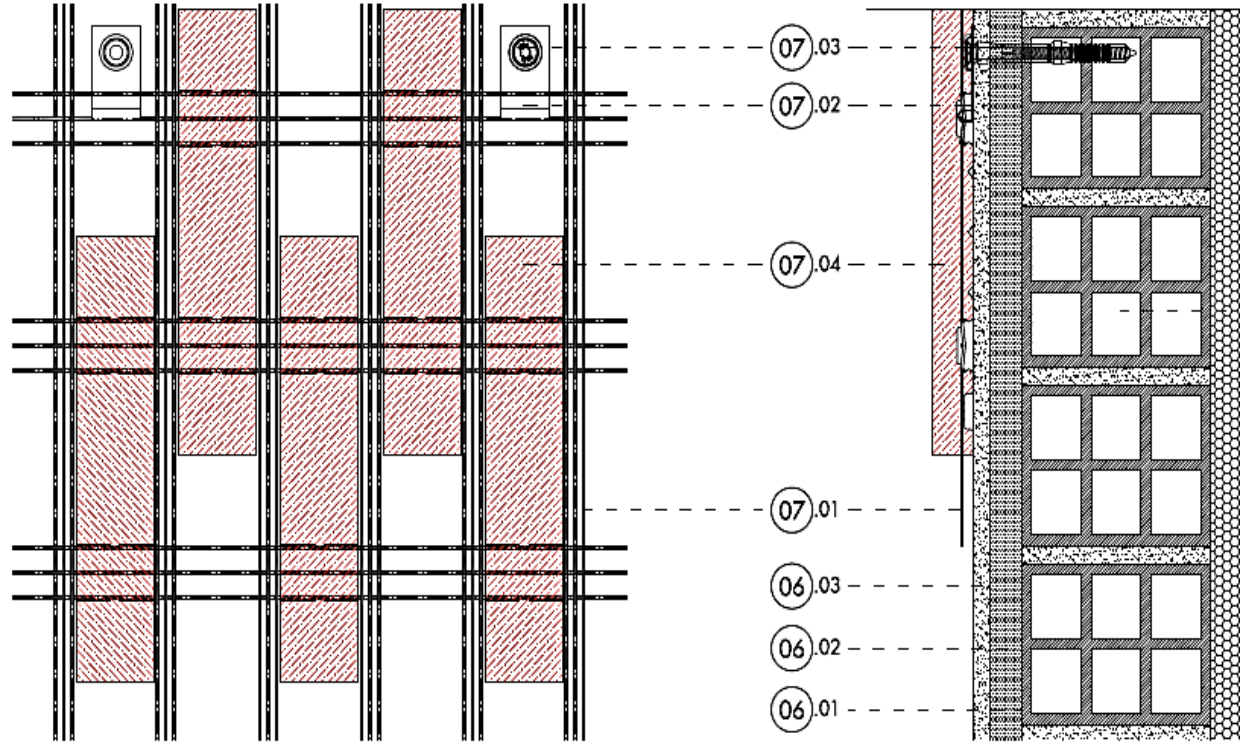

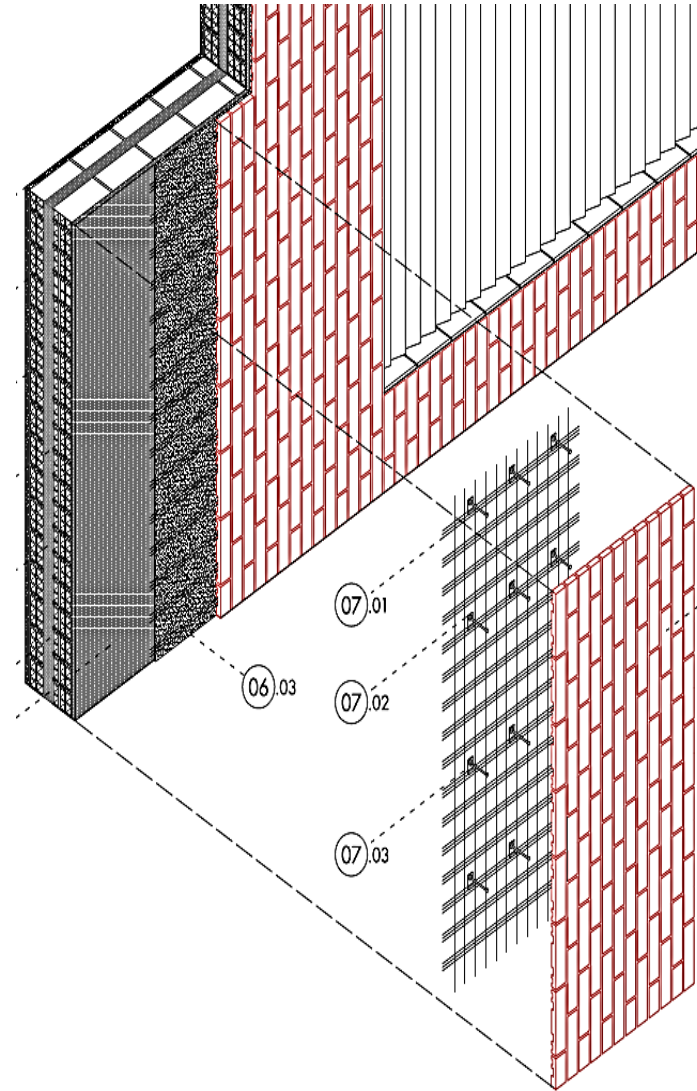



Rehabilitación del edificio  
Girasol en Madrid  
(Atelier Galante, 2019)  
fotos: Carlos de Miguel



Oficinas en Estambul (Turquía, 2018)



Opening  
Centro comercial en Teherán (Irán, 2019)



TOTT

Vivienda en Chicago (2020)





Baviera (Alemania, 2021)

Expo en Dubai (2021)





Expo en Dubai  
(2021)

Hospital en Maitland, Nueva Gales del Sur (Australia, 2021)





Hospital en Maitland, Nueva Gales del Sur (Australia, 2021)

# PREMIOS A LA INNOVACIÓN

**2016** Premio nacional XIII Bienal Española de Arquitectura y Urbanismo

Categoría: Mejor Producto para la arquitectura

**2014** Placa de honor de la AEC

Asociación Española de Científicos.

**2012** 1er Premio INNO Foro Verde 2012

en la categoría de mejor producto no vegetal, por Flexbrick Garden.

Salón Foro Verde, Feria de Girona, Asociación de Viveristas de Girona y Gremio de Jardinería de Cataluña.

**2011** 1er Premio Cataluña Construcción

en el apartado de Innovación en la Construcción.

Colegio de Aparejadores, Arquitectos técnicos e Ingenieros de la Edificación de Barcelona.

**2011** Finalista al Premio Construmat

en el apartado de Innovación Tecnológica.

Construmat 2011.

**Flexbrick**<sup>®</sup>  
dressing architecture

[www.flexbrick.net](http://www.flexbrick.net)